

NO	QTÉ / QTY	NO. PROD.	DESCRIPTION	LONGUEUR / LENGTH		OND / COR
				m	(")	
1	1	00614	SOLFLO MAX R125 N-P 1200mm (48")	5.933	233.600	40
2	1	00695	SOLFLO MAX R320 N-P 600mm (24")	1.304	51.350	13
3	1	06013	PLAQUE PEHD 1422mm x 1422mm x 1" BOUCHON	-	-	-
4	1	00645	SOLFLO MAX R320 N-P 250mm (10")	0.200	7.860	6
5	1	01630	DOUBLE CLOCHE 250mm (10") CLIP	-	-	-
6	0.082	02850	FEUILLE PEHD 1" x 56" x 56"	-	-	-
-	1	02799	CÂBLE DE LEVAGE 1/4"	11.278	-	-
-	12	04183	SERRE CÂBLE 1/4"	-	-	-

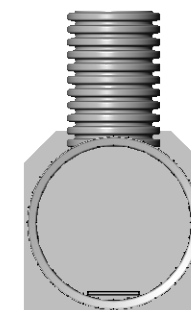
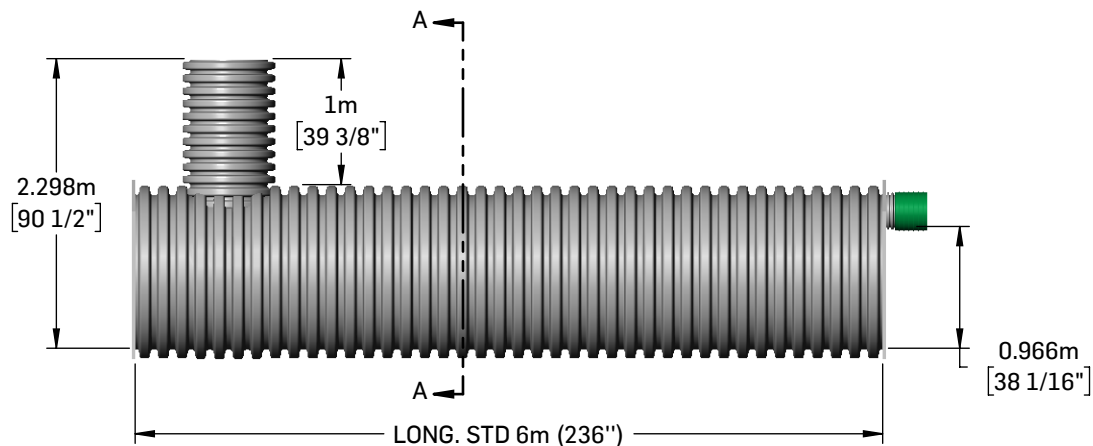
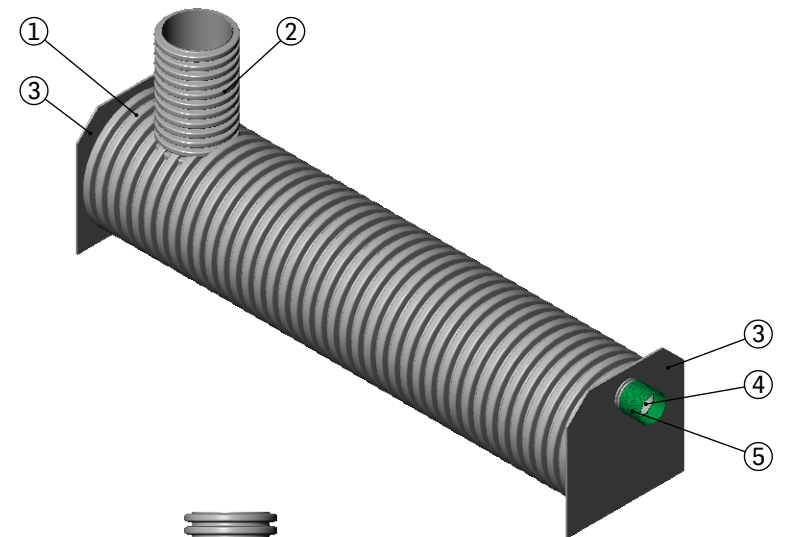
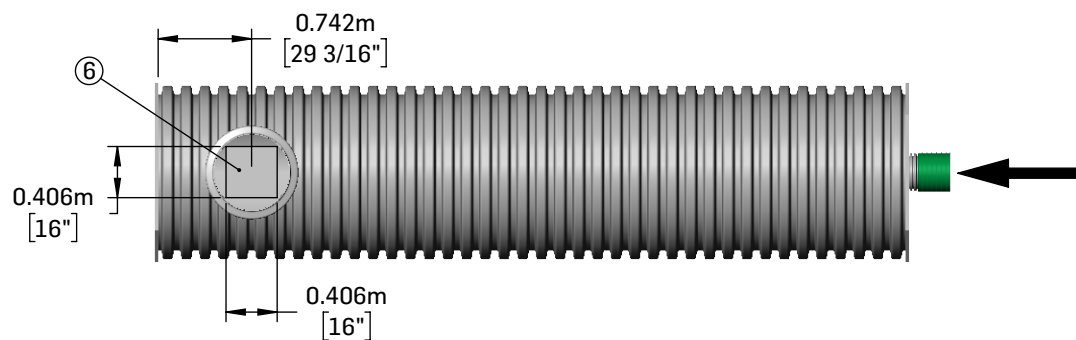

COUPE A-A

LES DIMENSIONS SONT POUR
RÉFÉRENCE SEULEMENT
ALL DIMENSIONS ARE
FOR REFERENCE ONLY

CE DOCUMENT EST LA PROPRIÉTÉ DE SOLENO.
IL NE DOIT EN AUCUN CAS ÊTRE REPRODUIT
OU TRANSMIS SANS UN CONSENTEMENT ÉCRIT.
THIS DOCUMENT IS THE PROPERTY OF SOLENO.
IT MAY NOT BE REPRODUCED
OR TRANSMITTED TO ANYONE WITHOUT EXPLICIT
WRITTEN CONSENT



1160 ROUTE 133
ST-JEAN-SUR-RICHELIEU, QC
J2X 4B6 CANADA
TEL 800.363.1471 FAX 450.347.3372
soleno.com

OBJET/OBJECT

RÉSERVOIR / SOLFLO MAX TANK 1200mm (48") X 6m (236") CHEMINÉE 600mm (24")

ÉCH./SCALE

1:60

NO. PRODUIT/PRODUCT

06234

DATE

2022-02-01

REV.

0