

DETAIL A

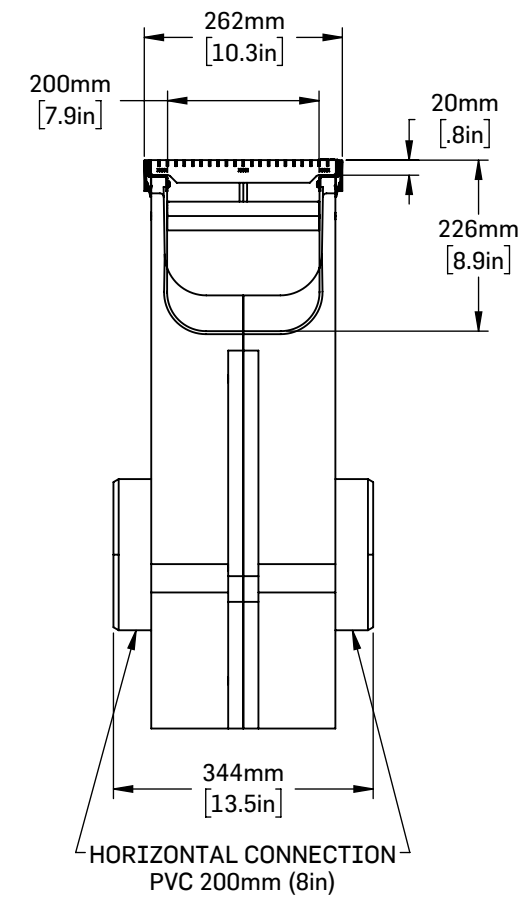

NOTES:

1. The vertical drains of the RECYFIX and TOP X range comply with standard EN 1433.
2. The data are indicative only and may change without notice.
3. Documentation for Hauraton products distributed by Soleno is found at soleno.com.
4. For any questions, contact your Soleno representative.

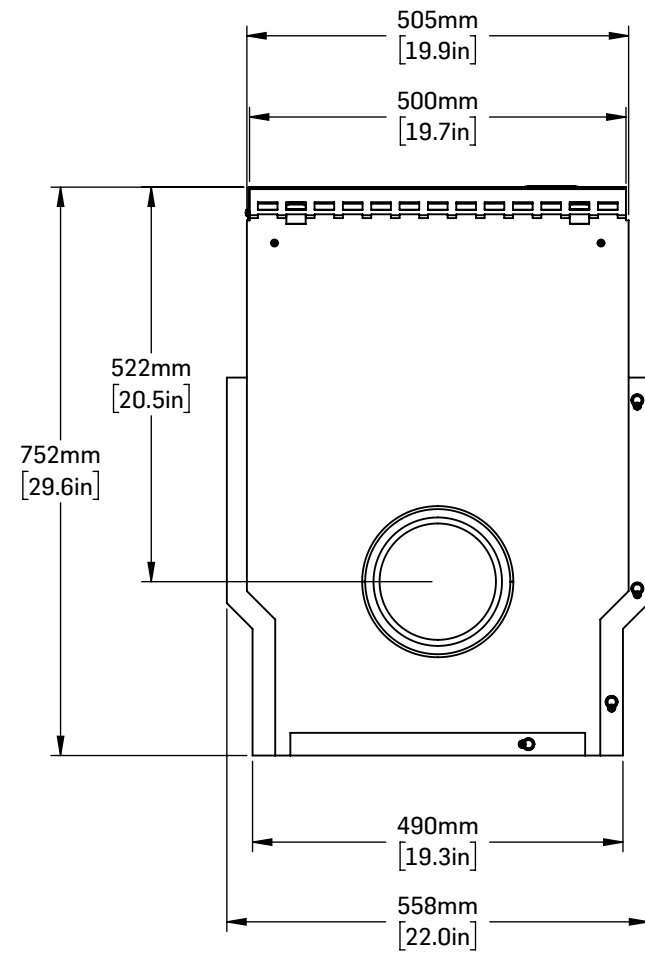

VERTICAL DRAIN RECYFIX PRO
GALVANIZED STEEL GRATE
MESH GRATING 10x30 mm (1.2x0.4 in)
CL. B125

06885 VERTICAL DRAIN RX PRO 200 GALVANIZED MESH GRATE 30X10mm B125

ITEM: HAU47256

REV 01.2023